



Business-
catalog 宣传画册
enterprise

中山市合新智能电子科技有限公司宣传画册



地 址：中山市黄圃镇马新兴圃大道中195号
服务热线：+86 0760-23307981
传 真：+86 0760-23126965
网 址：www.hexinntc.com



CONTENTS

目录



1

COMPANY PROFILE

| BRIEF INTRODUCTION



2

PRODUCTION EQUIPMENT

| EQUIPMENT STRENGTH

3



NTC TEMPERATURE SENSOR

| CWF SERIES

4



NTC THERMISTOR

- | MF58 SERIES
- | MF58D SERIES
- | MF52B/E/D SERIES
- | MF52B/E NTC THERMISTOR FOR MEDICAL
- | MF72 SERIES
- | MF11 SERIES
- | SMD SERIES
- | MF55 SERIES FILM

5



THE PRODUCT APPLICATION

| Product application

COMPANY PROFILE

公司简介

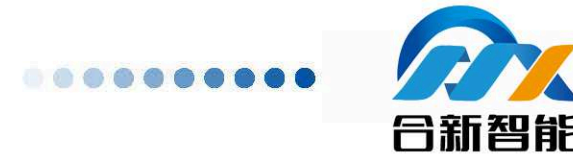

中山市合新智能电子科技有限公司(公司前身:中山市合新电子科技有限公司,以下简称“合新智能”)成立于2010年,位于广东中山市黄圃镇兴圃大道,是一家集高精度温度传感器研发、制造、销售服务为一体的高新技术企业。主要产品:负温度传感器,NTC热敏电阻,服务于家电、工业控制、医疗、通讯等行业。总投资2000万,现有员工110多人,管理、工程技术人员10多人,稳定技术工人90人,临时员工30人。

公司通过了ISO9001-2015质量管理体系认证,产品完全符合欧盟ROHS环保指令。公司拥有专业的实验室及可靠的质量检测和保证手段,品质保证系统健全完善,是国内一线品牌企业信赖的合作伙伴,各类型自动化生产设备、先进的实验设备。公司采用前沿的技术力量、先进的生产设备、成熟的生产技术工艺制定了一系列高效的运营体系!公司生产的高精度温度传感器、热敏电阻等产品,具有测温、测温精度高、响应速度快及阻值稳定性好等特点。

NTC温度传感器属于定制型产品,它不仅应用于电磁炉、电饭煲、烤箱、热水器、取暖器、空调、冷柜、饮水机、消毒柜、洗衣机、豆浆机等家电设备的测温,而且还广泛应用于汽车、物联网温控、电池、智能马桶、电热毯、电褥子过热保护、灯具、电动工具、医用体温探头、工业测温、园林控温和养殖业等其他各领域。

公司在中山和广安分别设有工厂,并在成都和浙江设有办事处!

公司始终遵循“关注客户,注重品质,价格公道,持续改进,打造名牌”的经营理念。竭诚欢迎国内外客户洽谈、交流、合作、共创辉煌。

Zhongshan Hexin Smart Electronics Technology Co., Ltd. (formerly known as Zhongshan Hexin Electronic Technology Co., Ltd., hereinafter referred to as "Hexin Intelligence") was established in 2010 and is located in Xingpu Avenue, Huangpu Town, Zhongshan City, Guangdong Province. It is a high-precision temperature sensor. The high-tech enterprise that integrates research and development, manufacturing, and sales services. The main products are: negative temperature sensors, NTC thermistors, serving home appliances, industrial control, medical care, communications and other industries. The total investment is 20 million. There are more than 110 employees, more than 10 management and engineering technicians, and 90 stable technical workers. There are 30 temporary employees.

The company has passed the ISO 9001-2015 quality management system certification, the product is in full compliance with the EU ROHS environmental protection directive. The company has a professional laboratory and reliable quality inspection and assurance means, and the quality assurance system is perfect. It is a trusted partner of domestic first-line brand companies, and various types of automated production equipment and advanced experimental equipment. The company uses the frontier technical force, advanced production equipment, mature production technology technology to develop a series of efficient operating systems! The high-precision temperature sensors, thermistors and other products produced by the company are characterized by high temperature measurement, high speed measurement accuracy, fast response speed and good resistance stability.

NTC temperature sensor is a customized product. It is not only used in the measurement and control of electrical appliances such as induction cookers, rice cookers, ovens, water heaters, heaters, air conditioners, refrigerators, drinking machines, disinfection cabinets, washing machines, and soybean milk machines. It is also widely used in other fields such as automobiles, Internet of Things temperature control, batteries, smart toilets, electric blankets, power over heat protection, lamps, electric tools, medical temperature probes, industrial temperature measurement, garden temperature control and aquaculture.

The company has set up factories in Zhongshan and Guang'an respectively, and set up offices in Chengdu and Zhejiang!

The company has always followed the business concept of "paying attention to customers, paying attention to quality, fair prices, continuous improvement, and creating famous brands." Warmly welcome domestic and foreign customers to negotiate, exchange, cooperation and create brilliant.



THE PRODUCT APPLICATION 产品应用

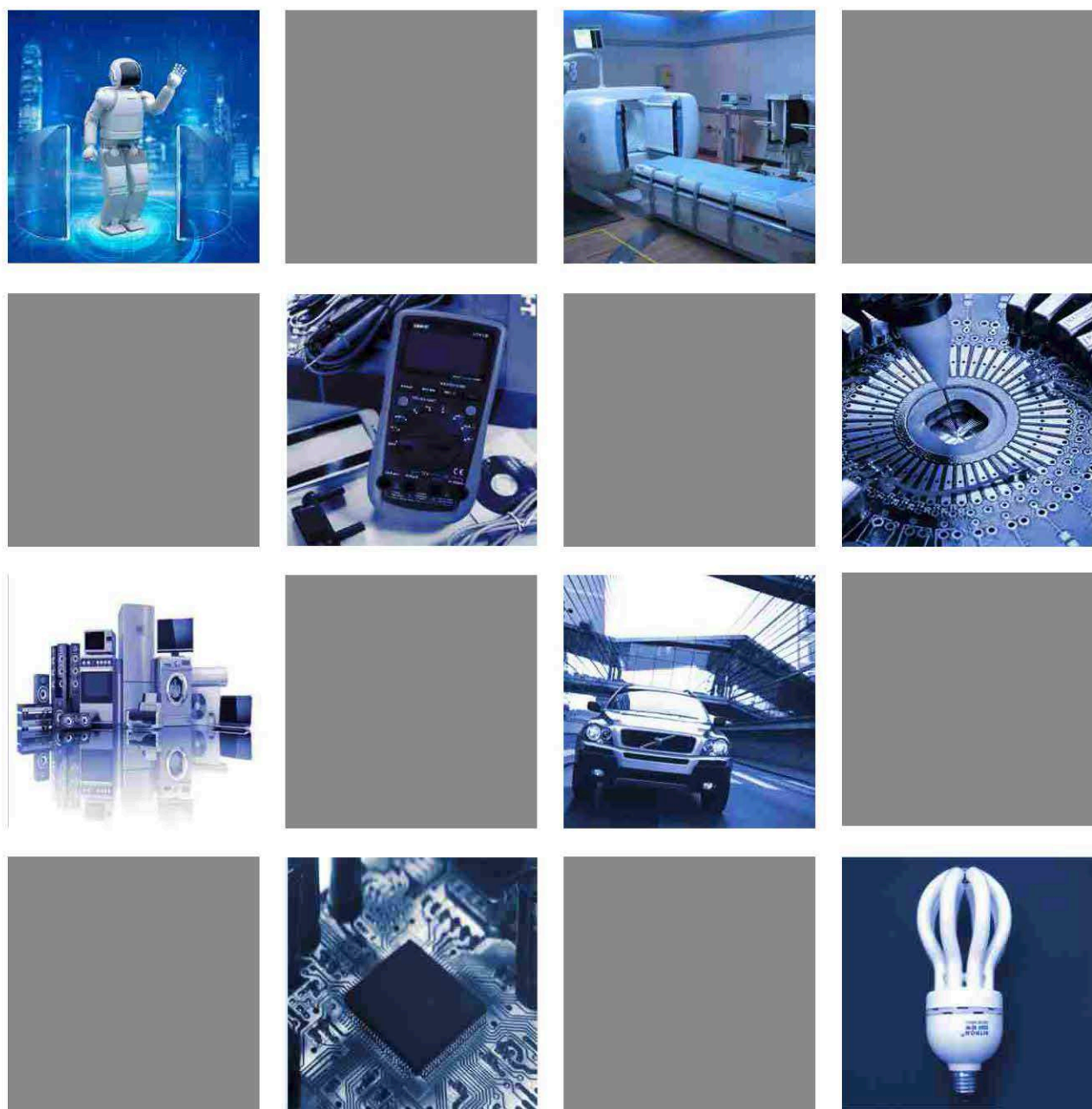

PRODUCTION EQUIPMENT 生产设备



NTC温度传感器系列 NTC TEMPERATURE SENSOR



NTC TEMPERATURE SENSOR NTC温度传感器

特点 | FEATURES

- | | |
|--|---|
| <ol style="list-style-type: none"> 1.CWF系列产品为NTC热敏电阻温度传感器 2.产品性能稳定、可长期工作(年电阻值漂移率$\leq 5\%$) 3.电阻值和B值精度高、一致性好、可互换(电阻值和B值精度分别可达$\pm 1\%$) 4.灵敏度高、反应速度快,电阻温度系数可达$-(2\sim 5)\%/^{\circ}\text{C}$ 5.具有良好的绝缘密封性和抗机械碰撞、抗折弯能力、可靠性高 6.可根据使用的安装条件封装,便于用户安装 7.测温精度高 | <ol style="list-style-type: none"> 1.CWF series is specifically designed NTC thermistor temperature sensor. 2.Long time stability, annual resistance excursion rate $\leq 5\%$. 3.High precision resistance and B value, good consistency, interchangeable. (Resistance and B value tolerance can be $\pm 1\%$) 4.High sensitivity, fast response, resistance temperature coefficient can be $-(2\sim 5)\%/^{\circ}\text{C}$ 5.Good insulation, anti mechanical collision, anti bending, high reliability. 6.Can be encapsulated upon specific installation condition, convenient for installation. 7.High temperature measurement precision. |
|--|---|

应用范围 | APPLICATION

应用于家用空调、汽车空调、冰箱、冰柜、酒柜、半导体、车载冰箱、热水器、咖啡壶、茶煲、微波炉、烤箱、饮水机、暖风机、洗碗机、消毒柜、洗衣机、烘干机、豆浆机、足浴盆、鱼缸水族、整体浴室等的温度测量与控制

Applied in the temperature measurement and control of home air conditioner, automobile air conditioner, refrigerator, freezer/wine cabinet, semiconductor car refrigerator water heater, coffee maker, tea cook/microwave oven, oven, drinking machine, warm machine, dish washer, disinfection tank, washing machine, drying machine, pediluvium basin, aquarium/soybean milk machine, bathroom, etc.

FOR TEMPERATURE MEASUREMENT 用于温度测量

CWF 系列 SERIES

B01系列产品用途:暖风机、油汀机、空调、酒柜、啤酒机、电源等
B01 series Application: Warm air blower, oil machine, air conditioning, beer dispenser, power supply, etc

产品性能简述

- 使用温度范围:
-30 $^{\circ}\text{C}$ ~+105 $^{\circ}\text{C}$ or -30 $^{\circ}\text{C}$ ~+125 $^{\circ}\text{C}$
- 耐电压:
AC1000V~AC1800V,35Sec
- 绝缘:
DC500V,Min.100M Ω ,35Sec
- 热反应时间:
 $\tau(63.2\%) \leq 15\text{Sec}$

说明

- 1.线材规格及长度可依客户要求定制,长度需 $\geq 40\text{mm}$.
- 2.依客户要求可于线材上装配绝缘套管.
- 3.尺寸(L $\geq 10\text{mm}$,D $\geq 3.0\text{mm}$)可依客户实际需求评估制作.

Product characteristic description

- Working temperature range
-30 $^{\circ}\text{C}$ ~+105 $^{\circ}\text{C}$ or -30 $^{\circ}\text{C}$ ~+125 $^{\circ}\text{C}$
- Voltage Withstanding
AC1000V~AC1800V,35Sec
- Insulation
DC500V,Min.100M Ω ,35Sec
- Thermal Time Constant
 $\tau(63.2\%) \leq 15\text{Sec}$

Notes

1. Wire length can be designed like customer's requirement Cable length should be $\geq 40\text{mm}$.
2. The insulation tube can be installed as per customer's request.
3. size(L $\geq 10\text{mm}$,D $\geq 3.0\text{mm}$) all the size can be made like customer's requirement.



B02系列产品用途:电磁炉、电源和表面贴装

B02 series Product use:induction cooker,metal form like switch power supply

产品性能简述

- 使用温度范围：
-30°C~+105°C or -30°C~+125°C or -30°C~+150°C
- 耐电压：
AC1000V~AC1800V,3Sec
- 绝缘：
DC500V,Min.100MΩ,3Sec
- 热反应时间：
 $\tau(63.2\%) \leq 15\text{Sec}$

说明

- 1.线材规格及长度可依客户要求定制，长度需 $\geq 40\text{mm}$ 。
- 2.依客户要求可于线材上装配绝缘套管。
- 3.感温端子尺寸规格及客户实际需求评估制作。

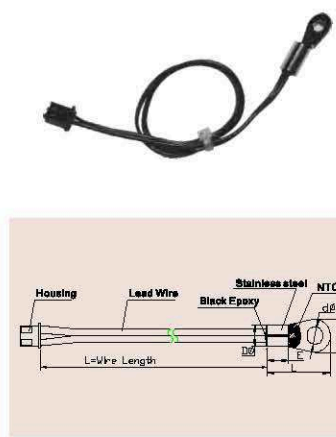

Product characteristic description

- Working temperature range
-30°C~+105°C or -30°C~+125°C or -30°C~+150°C
- Voltage Withstanding
AC1000V~AC1800V,3Sec
- Insulation
DC500V,Min.100MΩ,3Sec
- Thermal Time Constant
 $\tau(63.2\%) \leq 15\text{Sec}$

Notes

1. Wire length can be designed like customer's requirement Cable length shoube $\geq 40\text{mm}$.
2. The insulation tube can be installed as per customer's request.
3. Temperature terminal size spec and make based on customer's actual requirement.

B05系列产品用途:微波炉、烤箱、饭煲等

B05 series Product use:microwave oven,oven,rice cooker,etc

产品性能简述

- 使用温度范围：
-30°C~+105°C or -30°C~+125°C or -30°C~+200°C
- 耐电压：
AC1200V~AC2000V,3Sec
- 绝缘：
DC500V,Min.100MΩ,3Sec
- 热反应时间：
 $\tau(63.2\%) \leq 25\text{Sec}$

说明

- 1.线材规格及长度可依客户要求定制，长度需 $\geq 40\text{mm}$ 。
- 2.依客户要求可于线材上装配绝缘套管。
- 3.感温外壳尺寸规格及客户实际需求评估制作。

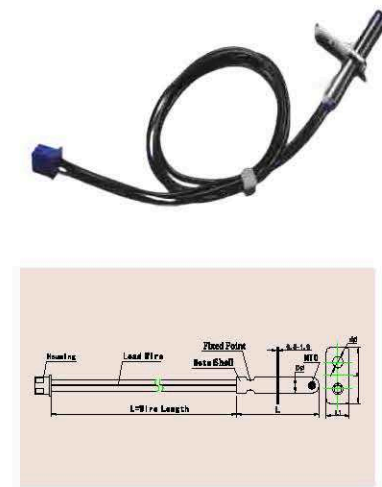

Product characteristic description

- Working temperature range:
-30°C~+105°C or -30°C~+125°C or -30°C~+200°C
- Voltage Withstanding:
AC1200V~AC2000V,3Sec
- Insulation:
DC500V,Min.100MΩ,3Sec
- Thermal Time Constant
 $\tau(63.2\%) \leq 25\text{Sec}$

Notes

1. Wire length can be designed like customer's requirement Cable length shoube $\geq 40\text{mm}$.
2. The insulation tube can be installed as per customer's request.
3. Temperature housing size can be designed as per customer's actual requirement.

B03系列产品用途:足浴盆、饮水机、鱼缸、水族箱等

B03 series Product use:pediluvium basin,drinking machine,Aquarium,etc

产品性能简述

- 使用温度范围：
-30°C~+105°C or -30°C~+125°C or -30°C~+200°C
- 耐电压：
AC1200V~AC2000V,3Sec
- 绝缘：
DC500V,Min.100MΩ,3Sec
- 热反应时间：
 $\tau(63.2\%) \leq 25\text{Sec}$

说明

- 1.线材规格及长度可依客户要求定制，长度需 $\geq 40\text{mm}$ 。
- 2.依客户要求可于线材上装配绝缘套管。
- 3.感温外壳尺寸(D $> 3.0\text{mm}$,L $\geq 10\text{mm}$)可依客户实际需求评估制作。

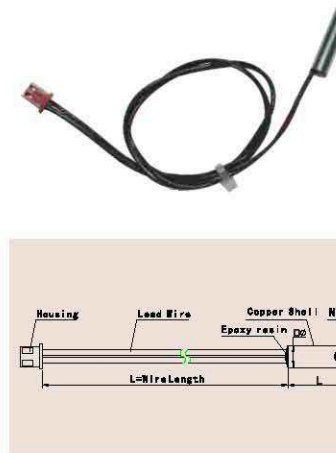

Product characteristic description

- Working temperature range
-30°C~+105°C or -30°C~+125°C or -30°C~+200°C
- Voltage Withstanding
AC1200V~AC2000V,3Sec
- Insulation
DC500V,Min.100MΩ,3Sec
- Thermal Time Constant
 $\tau(63.2\%) \leq 25\text{Sec}$

Notes

1. Wire length can be designed like customer's requirement Cable length shoube $\geq 40\text{mm}$.
2. The insulation tube can be installed as per customer's request.
3. (D $> 3.0\text{mm}$,L $\geq 10\text{mm}$)Temperature housing size can be designed as per customer's actual requirement.

B06系列产品用途:咖啡壶、热水器等

B06 series Product use:coffee maker,water heater,etc

产品性能简述

- 使用温度范围：
-30°C~+105°C or -30°C~+125°C or -30°C~+150°C
- 耐电压：
AC1000V~AC1800V,3Sec
- 绝缘：
DC500V,Min.100MΩ,3Sec
- 热反应时间：
 $\tau(63.2\%) \leq 75\text{Sec}$

说明

- 1.线材规格及长度可依客户要求定制，长度需 $\geq 40\text{mm}$ 。
- 2.依客户要求可于线材上装配绝缘套管。
- 3.感温外壳尺寸(D $\geq 4.0\text{mm}$,d $\geq 2.1\text{mm}$,L $\geq 18\text{mm}$)可依客户实际需求评估。

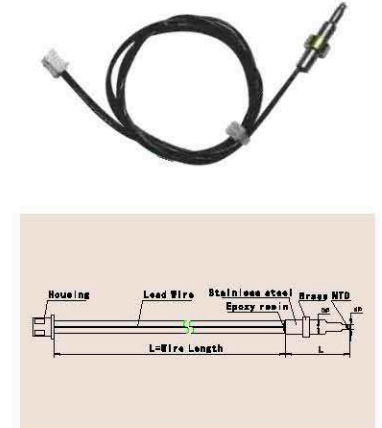

Product characteristic description

- Working temperature range:
-30°C~+105°C or -30°C~+125°C or -30°C~+150°C
- Voltage Withstanding
AC1000V~AC1800V,3Sec
- Insulation:
DC500V,Min.100MΩ,3Sec
- Thermal Time Constant
 $\tau(63.2\%) \leq 75\text{Sec}$

Notes

1. Wire length can be designed like customer's requirement Cable length shoube $\geq 40\text{mm}$.
2. The insulation tube can be installed as per customer's request.
3. Temperature housingsize (D $\geq 4.0\text{mm}$,d $\geq 2.1\text{mm}$,L $\geq 18\text{mm}$)can designed per customer actual requirement.

B04系列产品用途:冰箱、冷库等

B04 series Product use:refrigerator,freezer,etc

产品性能简述

- 使用温度范围：
-40°C~+80°C
- 耐电压：
AC1500V~AC2500V,3Sec
- 绝缘：
DC500V,Min.100MΩ,3Sec
- 热反应时间：
 $\tau(63.2\%) \leq 30\text{Sec}$

说明

- 1.线材规格及长度可依客户要求定制，长度需 $\geq 40\text{mm}$ 。
- 2.依客户要求可于线材上装配绝缘套管。
- 3.感温外壳尺寸(D $> 4.5\text{mm}$,L $\geq 10\text{mm}$)可依客户实际需求评估制作。



Product characteristic description

- Working temperature range:
-40°C~+80°C
- Voltage Withstanding:
AC1500V~AC2500V,3Sec
- Insulation:
DC500V,Min.100MΩ,3Sec
- Thermal Time Constant:
 $\tau(63.2\%) \leq 30\text{Sec}$

Notes

1. Wire length can be designed like customer's requirement Cable length shoube $\geq 40\text{mm}$.
2. The insulation tube can be installed as per customer's request.
3. Temperature housingsize (D $> 4.5\text{mm}$,L $\geq 10\text{mm}$)can be designed per customer actual requirement.

B07系列产品用途:户外浴缸等产品

B07 series Product use:Outdoor bath crock and other products

产品性能简述

- 使用温度范围：
-40°C~+105°C
- 耐电压：
AC2000V,3Sec
- 绝缘：
DC500V,Min.100MΩ,3Sec
- 热反应时间：
 $\tau(63.2\%) \leq 25\text{Sec}$

说明

- 1.产品安装使用方便,抗寒、抗热性能优良可长、期保持正常工作。
- 2.线材规格及长度可依客户要求定制。
- 3.感温外壳尺寸可依客户实际需求评估制作。

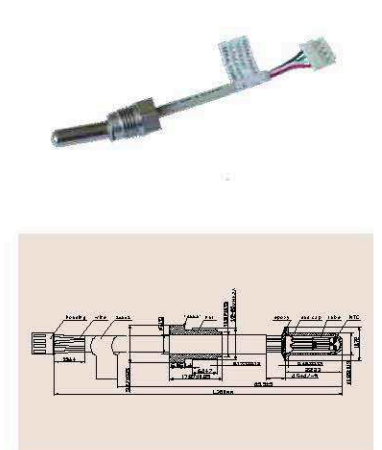

Product characteristic description

- Working temperature range:
-40°C~+105°C
- Voltage Withstanding:
AC2000V,3Sec
- Insulation:
DC500V,Min.100MΩ,3Sec
- Thermal Time Constant
 $\tau(63.2\%) \leq 25\text{Sec}$

Notes

1. Product easy for installation ,cold resist,thermal performance,can work under under loading.
2. cable length can be made per customer requirement.
3. Temperature housing size can be designed per customer actual requirement.

B08系列产品用途:豆浆机等

B08 series Product uses soybean milk machine, etc.

产品性能简述

- 使用温度范围：
-30°C ~ +105°C or -30°C ~ +125°C
- 耐电压：
AC1000V~AC2000V, 3Sec
- 绝缘：
DC500V, Min. 100MΩ, 35Sec
- 热反应时间：
 $\tau(63.2\%) \leq 35\text{Sec}$

说明

1. 线材规格及长度可依客户要求定制，长度需 $\geq 40\text{mm}$ 。
2. 依客户要求可于线材上装配绝缘套管。
3. 感温外壳尺寸(L1 $\geq 15\text{mm}$, L2 $\geq 5\text{mm}$)可依客户实际需求评估制作。

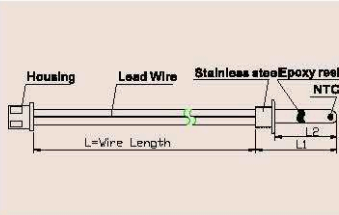

Product characteristic description

- Working temperature range:
-30°C ~ +105°C or -30°C ~ +125°C
- Voltage Withstanding:
AC1000V~AC2000V, 3Sec
- Insulation:
DC500V, Min. 100MΩ, 35Sec
- Thermal Time Constant:
 $\tau(63.2\%) \leq 35\text{Sec}$

Notes

1. Wire length can be designed like customer's requirement Cable length should be $\geq 40\text{mm}$.
2. The insulation tube can be installed as per customer's request.
3. Temperature housing size (L1 $\geq 15\text{mm}$, L2 $\geq 5\text{mm}$) can be designed per customer actual requirement.

B11系列产品用途:空调等

B11 series Product uses air conditioner, etc.

产品性能简述

- 使用温度范围：
-30°C ~ +105°C or -30°C ~ +125°C or -30°C ~ +150°C
- 耐电压：
AC1000V~AC2000V, 3Sec
- 绝缘：
DC500V, Min. 100MΩ, 35Sec
- 热反应时间：
 $\tau(63.2\%) \leq 25\text{Sec}$

说明

1. 线材规格及长度可依客户要求定制，长度需 $\geq 40\text{mm}$ 。
2. 依客户要求可于线材上装配绝缘套管。
3. 尺寸(D1 > 3.0mm, L2 $\geq 10\text{mm}$; D2 $\geq 3.0\text{mm}$, L2 $\geq 10\text{mm}$)可依客户实际需求评估。

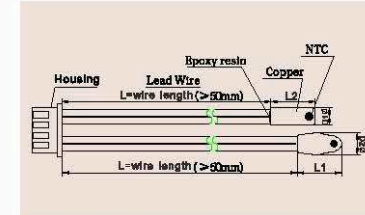

Product characteristic description

- Working temperature range:
-30°C ~ +105°C or -30°C ~ +125°C or -30°C ~ +150°C
- Voltage Withstanding:
AC1000V~AC2000V, 3Sec
- Insulation:
DC500V, Min. 100MΩ, 35Sec
- Thermal Time Constant:
 $\tau(63.2\%) \leq 25\text{Sec}$

Notes

1. Wire length can be designed like customer's requirement Cable length should be $\geq 40\text{mm}$.
2. The insulation tube can be installed as per customer's request.
3. Size (D1 > 3.0mm, L2 $\geq 10\text{mm}$; D2 $\geq 3.0\text{mm}$, L2 $\geq 10\text{mm}$) can be designed per customer actual requirement.

B09系列产品用途:烧烤叉、油炸锅等

B09 series Product uses barbecue fork, fryer, etc.

产品性能简述

- 使用温度范围：
-30°C ~ +105°C or -30°C ~ +200°C or -30°C ~ +260°C
- 耐电压：
AC1000V~AC2000V, 3Sec
- 绝缘：
DC500V, Min. 100MΩ, 35Sec
- 热反应时间：
 $\tau(63.2\%) \leq 25\text{Sec}$

说明

1. 线材规格及长度可依客户要求定制，长度需 $\geq 40\text{mm}$ 。
2. 依客户要求可于线材上装配绝缘套管。
3. 感温外壳尺寸(L $\geq 30\text{mm}$)可依客户实际需求评估制作。

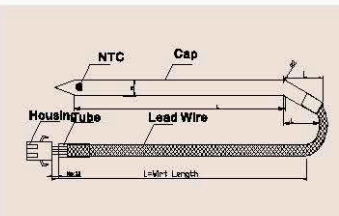

Product characteristic description

- Working temperature range:
-30°C ~ +105°C or -30°C ~ +200°C or -30°C ~ +260°C
- Voltage Withstanding:
AC1000V~AC2000V, 3Sec
- Insulation:
DC500V, Min. 100MΩ, 35Sec
- Thermal Time Constant:
 $\tau(63.2\%) \leq 25\text{Sec}$

Notes

1. Wire length can be designed like customer's requirement Cable length should be $\geq 40\text{mm}$.
2. The insulation tube can be installed as per customer's request.
3. L $\geq 30\text{mm}$ Temperature housing size can be designed as per customer's actual requirement.

B12系列产品用途:工业大烤箱、凹炉等产品

B12 series Product uses industrial large oven, concave furnace and other products

产品性能简述

- 使用温度范围：
-40°C ~ +250°C
- 耐电压：
AC2500V, 3Sec
- 绝缘：
DC500V, Min. 100MΩ, 35Sec
- 热反应时间：
 $\tau(63.2\%) \leq 75\text{Sec}$

说明

1. 线材规格及长度可依客户要求定制，长度需 $\geq 40\text{mm}$ 。
2. 依客户要求可于线材上装配绝缘套管。
3. 感温外壳尺寸可依客户实际需求评估制作。

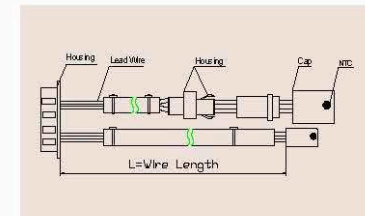

Product characteristic description

- Working temperature range:
-40°C ~ +250°C
- Voltage Withstanding:
AC2500V, 3Sec
- Insulation:
DC500V, Min. 100MΩ, 35Sec
- Thermal Time Constant:
 $\tau(63.2\%) \leq 75\text{Sec}$

Notes

1. Wire length can be designed like customer's requirement Cable length should be $\geq 40\text{mm}$.
2. The insulation tube can be installed as per customer's request.
3. Temperature housing size can be designed per customer actual requirement.

B10系列产品用途:热水器、太阳能等

B10 series Product uses water heater, kettle, etc.

产品性能简述

- 使用温度范围：
-30°C ~ +105°C or -30°C ~ +125°C
- 耐电压：
AC1000V~AC2000V, 3Sec
- 绝缘：
DC500V, Min. 100MΩ, 35Sec
- 热反应时间：
 $\tau(63.2\%) \leq 25\text{Sec}$

说明

1. 线材规格及长度可依客户要求定制，长度需 $\geq 40\text{mm}$ 。
2. 依客户要求可于线材上装配绝缘套管。
3. 感温外壳尺寸(L1 $\geq 15\text{mm}$, L2 $\geq 3\text{mm}$)可依客户实际需求评估制作。

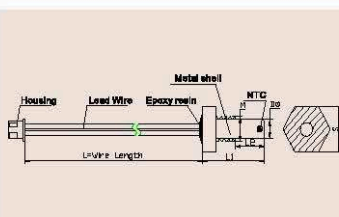

Product characteristic description

- Working temperature range:
-30°C ~ +105°C or -30°C ~ +125°C
- Voltage Withstanding:
AC1000V~AC2000V, 3Sec
- Insulation:
DC500V, Min. 100MΩ, 35Sec
- Thermal Time Constant:
 $\tau(63.2\%) \leq 25\text{Sec}$

Notes

1. Wire length can be designed like customer's requirement Cable length should be $\geq 40\text{mm}$.
2. The insulation tube can be installed as per customer's request.
3. Temperature housing size (L1 $\geq 15\text{mm}$, L2 $\geq 3\text{mm}$) can be designed per customer actual requirement.

B13系列产品用途:咖啡壶、水壶等

B13 series Product uses coffee maker, kettle, etc.

产品性能简述

- 使用温度范围：
-30°C ~ +105°C or -30°C ~ +125°C or -30°C ~ +250°C
- 耐电压：
AC1200V~AC2000V, 3Sec
- 绝缘：
DC500V, Min. 100MΩ, 35Sec
- 热反应时间：
 $\tau(63.2\%) \leq 25\text{Sec}$

说明

1. 产品安装使用方便、抗振、抗热性能优良、可长期稳定工作。
2. 线材规格及长度可依客户要求定制。
3. 感温外壳尺寸(D $\geq 4.0\text{mm}$, L $\geq 15\text{mm}$)可依客户实际需求评估制作。

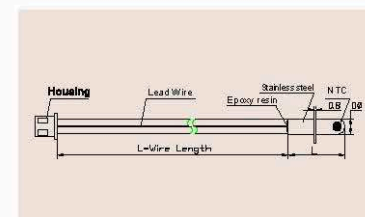

Product characteristic description

- Working temperature range:
-30°C ~ +105°C or -30°C ~ +125°C or -30°C ~ +250°C
- Voltage Withstanding:
AC1200V~AC2000V, 3Sec
- Insulation:
DC500V, Min. 100MΩ, 35Sec
- Thermal Time Constant:
 $\tau(63.2\%) \leq 25\text{Sec}$

Notes

1. (Product easy for installation, cold resist, thermal performance, can work under under loading.)
2. (Cable length can be made per customer requirement.)
3. (Temperature housing size (D $\geq 4.0\text{mm}$, L $\geq 15\text{mm}$) can be designed per customer actual requirement.)

B14系列产品用途:咖啡壶, 发热盘等
B14 series Product uses:coffee maker,hot plate,etc

产品性能简述

- 使用温度范围：
-30°C~+105°C or -30°C~+125°C or -30°C~+250°C
- 耐电压：
AC1200V~AC1800V,3Sec
- 绝缘：
DC500V,Min.100MΩ,3Sec
- 热反应时间：
τ(63.2%) ≤ 30Sec

说明

- 1.线材规格及长度可依客户要求定制,长度需≥40mm.
- 2.依客户要求可于线材上装配绝缘套管.
- 3.感温外壳尺寸(D≥6.0mm,L≥20mm)可依客户实际需求评估制作.

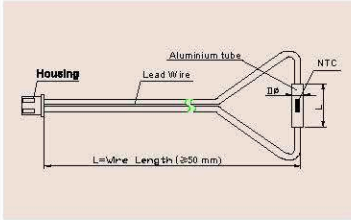
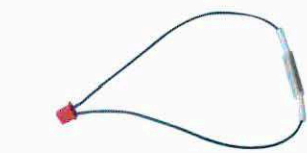

Product characteristic description

- Working temperature range:
-30°C~+105°C or -30°C~+125°C or -30°C~+250°C
- Voltage Withstanding:
AC1200V~AC1800V,3Sec
- Insulation:
DC500V,Min.100MΩ,3Sec
- Thermal Time Constant:
τ(63.2%) ≤ 30Sec

Notes

- 1.Wire length can be designed like customer's requirement.Cable length shoube ≥40mm.
- 2.The Insulation tube can be installed as per customer's request.
- 3.Temperature housing size(D≥6.0mm,L≥20mm) can be designed per customer actual requirement.

B15系列产品用途:直发器,发热盘等
B15 series Product uses:hair straightener,hot plate,etc

产品性能简述

- 使用温度范围：
-30°C~+125°C or -30°C~+250°C
- 耐电压：
AC1000V~AC1800V,3Sec
- 绝缘：
DC500V,Min.100MΩ,3Sec
- 热反应时间：
τ(63.2%) ≤ 25Sec

说明

- 1.线材规格及长度可依客户要求定制,长度需≥40mm.
- 2.依客户要求可于线材上装配绝缘套管.
- 3.感温外壳尺寸(D≥6.0mm,L≥20mm)可依客户实际需求评估制作.

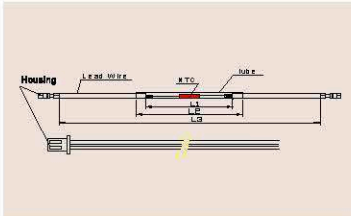

Product characteristic description

- Working temperature range:
-30°C~+125°C or -30°C~+250°C
- Voltage Withstanding:
AC1000V~AC1800V,3Sec
- Insulation:
DC500V,Min.100MΩ,3Sec
- Thermal Time Constant:
τ(63.2%) ≤ 25Sec

Notes

- 1.Wire length can be designed like customer's requirement.Cable length shoube ≥40mm.
- 2.The Insulation tube can be installed as per customer's request.
- 3.D≥6.0mm,L≥20mm]Temperature housing size can be designed as per customer's actual requirement.

B16系列产品用途:饭煲, 热水器,电压力锅等
B16 series Product uses:rice cooker,water heater,Electric pressure cooker,etc

产品性能简述

- 使用温度范围：
-30°C~+105°C or -30°C~+125°C or -30°C~+200°C
- 耐电压：
AC1200V~AC2000V,3Sec
- 绝缘：
DC500V,Min.100MΩ,3Sec
- 热反应时间：
τ(63.2%) ≤ 15Sec

说明

- 1.线材规格及长度可依客户要求定制,长度需≥40mm.
- 2.依客户要求可于线材上装配绝缘套管.
- 3.感温外壳尺寸(D≥3.5mm,L≥20mm)可依客户实际需求评估制作.
- 4.L3属连接地线,依客户需求可取消.

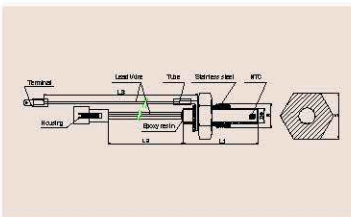

Product characteristic description

- Working temperature range:
-30°C~+105°C or -30°C~+125°C or -30°C~+200°C
- Voltage Withstanding:
AC1200V~AC2000V,3Sec
- Insulation:
DC500V,Min.100MΩ,3Sec
- Thermal Time Constant:
τ(63.2%) ≤ 15Sec

Notes

- 1.Wire length can be designed like customer's requirement.Cable length shoube ≥40mm.
- 2.The Insulation tube can be installed as per customer's request.
- 3.Temperature housing size(D≥3.5mm,L≥20mm)can be designed per customer actual requirement.
- 4.L3 is earth cable.It can be cancelled if necessary the customer demand can be cancelled.)

B17系列产品用途:洗碗机等产品
B17 series Product use:Dish washer and other products

产品性能简述

- 使用温度范围：
-30°C~+125°C
- 耐电压：
AC3750V,3Sec
- 绝缘：
DC500V,Min.100MΩ,3Sec
- 热反应时间：
τ(63.2%) ≤ 15Sec

说明

- 1.产品安装使用方便,抗热,抗热性能优良,可长期负荷正常工作.
- 2.依客户实际需求,可以做出不同电性翻之产品.

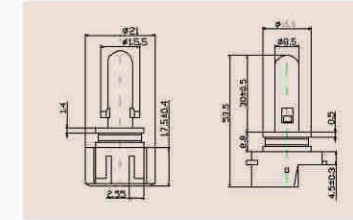

Product characteristic description

- Working temperature range:
-30°C~+125°C
- Voltage Withstanding:
AC3750V,3Sec
- Insulation:
DC500V,Min.100MΩ,3Sec
- Thermal Time Constant:
τ(63.2%) ≤ 15Sec

Notes

- 1.Product easy for installation ,cold resist,thermal performance,can work under under loading.
- 2.According to the customer demand, can make different product with different characteristic.

B18系列产品用途:饭煲、电压力锅等
B18 series Product uses:rice cooker,Electric pressure cooker,etc

产品性能简述

- 使用温度范围：
-30°C~+125°C or -30°C~+150°C
- 耐电压：
AC1200V~AC2000V,3Sec
- 绝缘：
DC500V,Min.100MΩ,3Sec
- 热反应时间：
τ(63.2%) ≤ 30Sec

说明

- 1.线材规格及长度可依客户要求定制(L≥50mm,L3≥50mm).
- 2.依客户要求可于线材上装配绝缘套管.
- 3.感温外壳尺寸(D≥5.0mm,L≥30mm)可依客户实际需求评估制作.
- 4.L3属连接地线,依客户需求可取消.

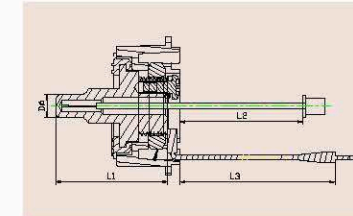

Product characteristic description

- Working temperature range:
-30°C~+125°C or -30°C~+150°C
- Voltage Withstanding:
AC1200V~AC2000V,3Sec
- Insulation:
DC500V,Min.100MΩ,3Sec
- Thermal Time Constant:
τ(63.2%) ≤ 30Sec

Notes

- 1.specifications wire length can be designed like customer's requirement(L≥50mm,L3≥50mm).
- 2.According to the customer request to the assembly wire electrical Insulators.
3. Temperature housing size(D≥5.0mm,L≥30mm) can be designed per customer actual requirement.
- 4.L3 is earth cable.It can be cancelled if necessary the customer demand can be cancelled.

B19系列产品用途:饭煲等
B19 series Product uses:rice cooker,etc

产品性能简述

- 使用温度范围：
-30°C~+125°C or -30°C~+150°C
- 耐电压：
AC1200V~AC2000V,3Sec
- 绝缘：
DC500V,Min.100MΩ,3Sec
- 热反应时间：
τ(63.2%) ≤ 35Sec

说明

- 1.线材规格及长度可依客户要求定制.
- 2.依客户要求可于线材上装配绝缘套管.
- 3.感温外壳尺寸(OD≥26.4mm,H≥7.5mm)可依客户实际需求评估制作.
- 4.黄色连接地线,依客户需求可取消.

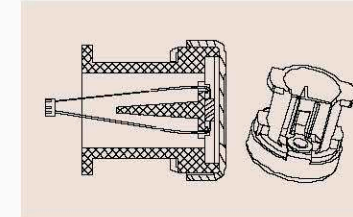

Product characteristic description

- Working temperature range:
-30°C~+125°C or -30°C~+150°C
- Voltage Withstanding:
AC1200V~AC2000V,3Sec
- Insulation:
DC500V,Min.100MΩ,3Sec
- Thermal Time Constant:
τ(63.2%) ≤ 35Sec

Notes

- 1.wire length can be designed like customer's requirement.
- 2.According to the customer request to the assembly wire electrical Insulators.
- 3.Temperature housing size(OD≥26.4mm,H≥7.5mm) can be designed per customer actual requirement.
- 4.The yellow earth cable can be cancelled if necessary according to the customer demand can be cancelled).

ECLAT
荣誉证书

